

SPECTRUM DIGITAL INCORPORATED			
Title:	DA830/L127/L137 PROTOMODULE		
Page Contents:	AUDIO / EXPANSION COINNECTOR 1		
Size: B	DWG NO	511742-0001	Revision: A
Date:	Friday, November 14, 2008	Sheet 2	of 5

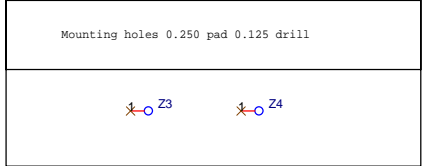

SPECTRUM DIGITAL INCORPORATED			
Title: DA830/L127/L137 PROTOMODULE			
Page Contents: EXPANSION 2			
Size: B	DWG NO	511742-0001	Revision: A
Date:	Friday, November 14, 2008	Sheet 3 of 5	

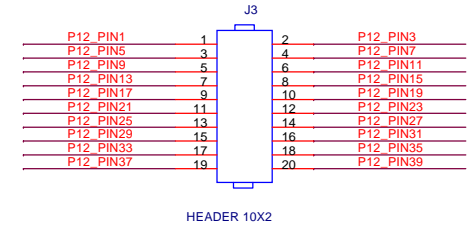
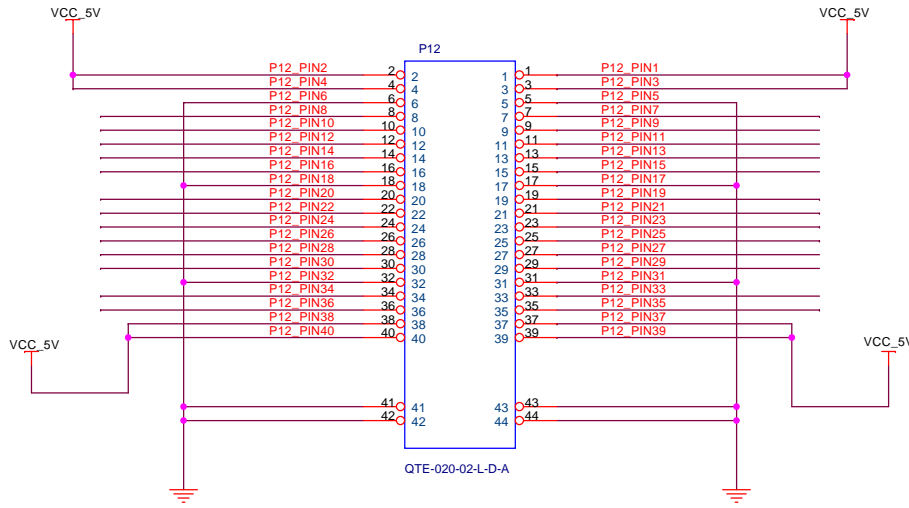
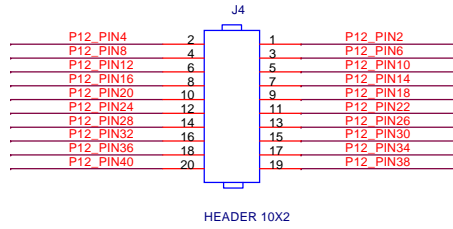
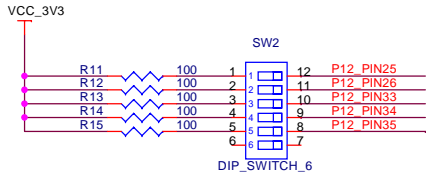
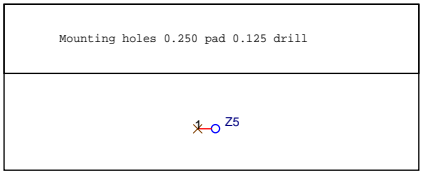
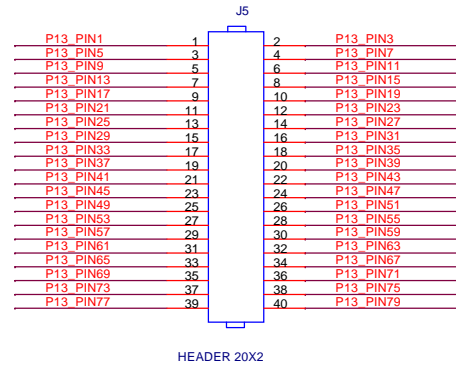
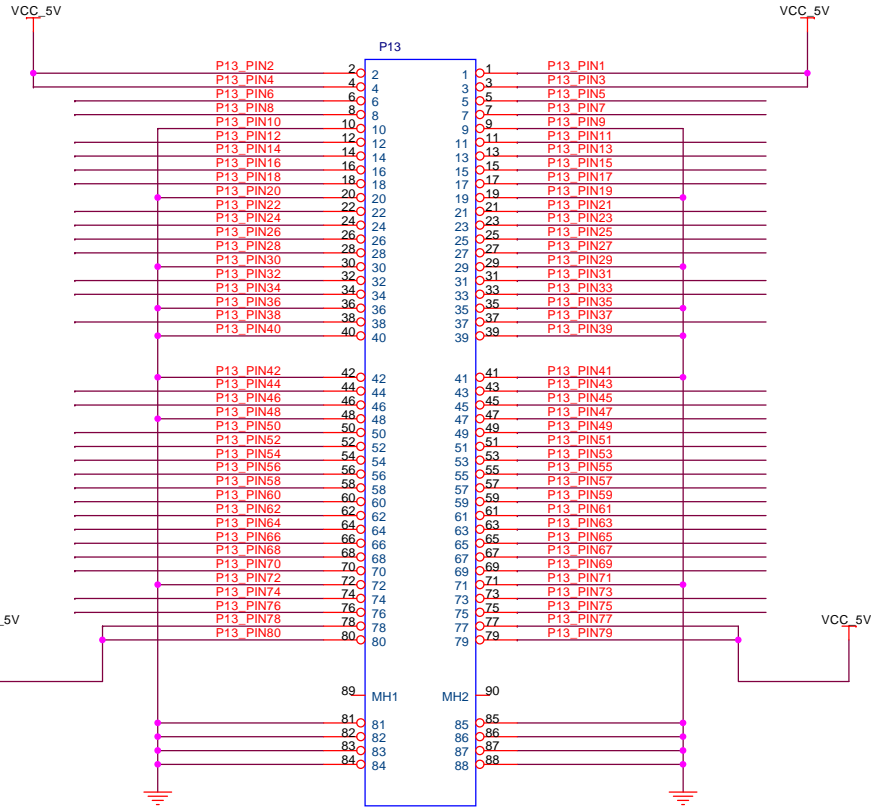
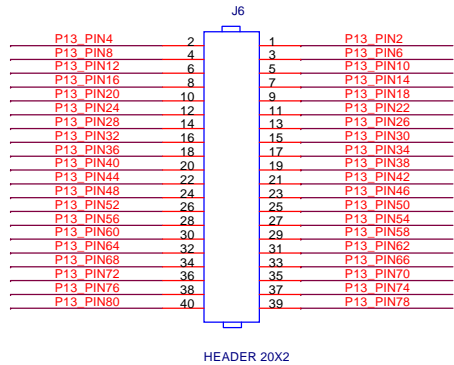
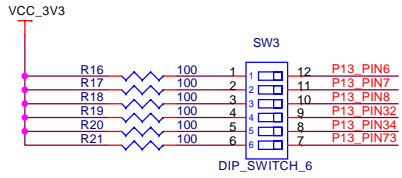

SPECTRUM DIGITAL INCORPORATED			
Title: DA830/L127/L137 PROTOMODULE			
Page Contents: EXPANSION 3			
Size: B	DWG NO	511742-0001	Revision: A
Date:	Friday, November 14, 2008	Sheet 4 of 5	

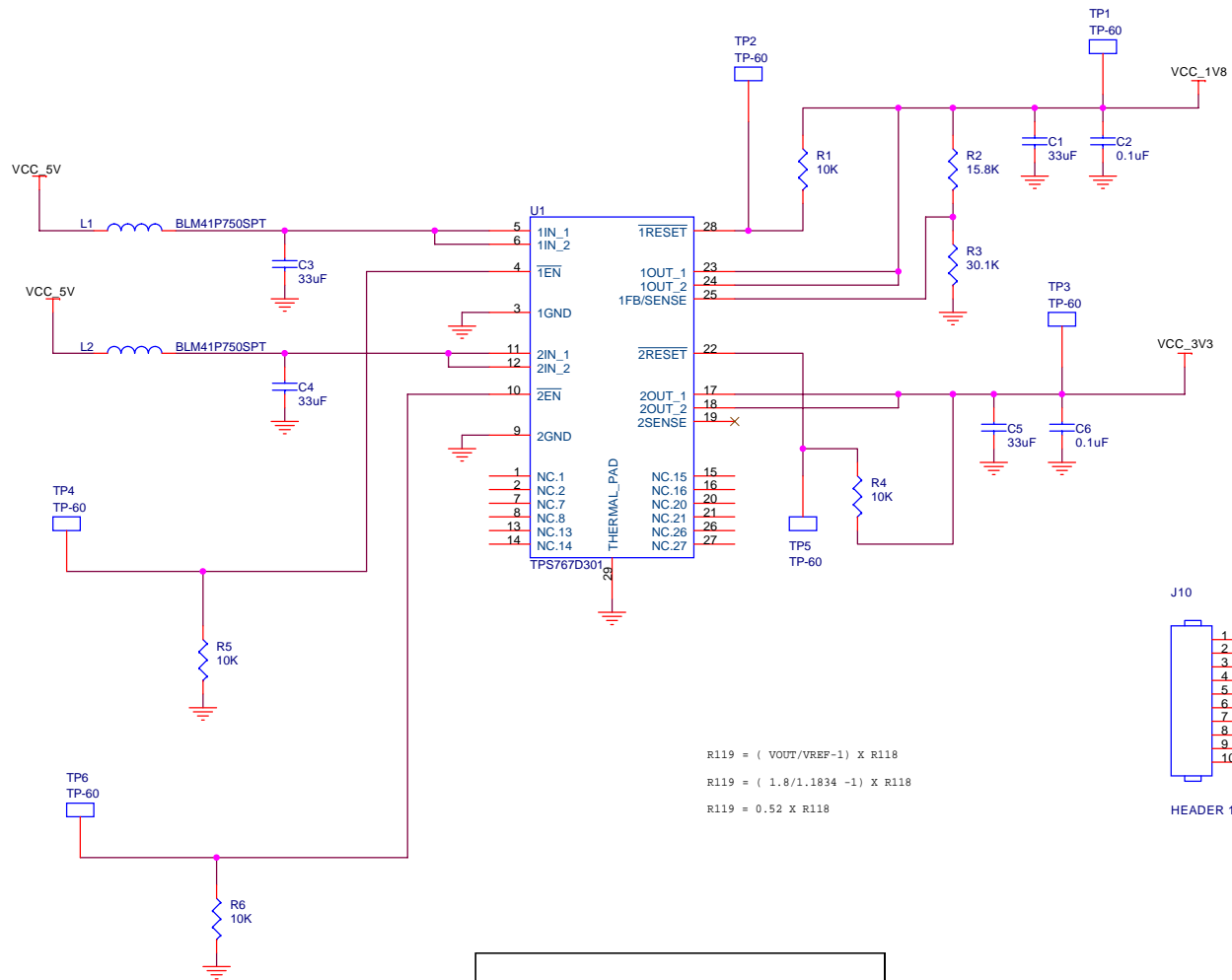

$$R119 = (V_{OUT}/V_{REF} - 1) \times R118$$

$$R119 = (1.8/1.1834 - 1) \times R118$$

$$R119 = 0.52 \times R118$$

Mounting holes 0.250 pad 0.125 drill

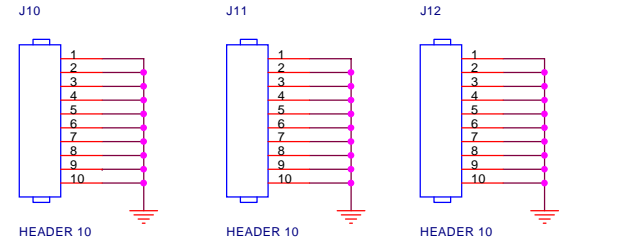
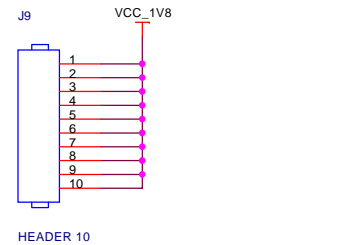
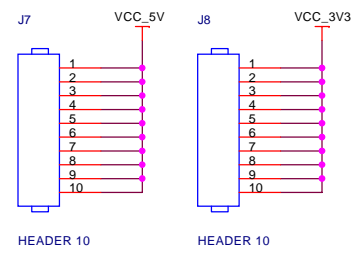
SPECTRUM DIGITAL INCORPORATED			
Title: DA830/L127/L137 PROTOMODULE			
Page Contents: USER SWITCHES LEDES			
Size: B	DWG NO	511742-0001	Revision: A
Date:	Friday, November 14, 2008	Sheet 5 of	5